



Qu**ARTZ** by ACO

Shower drains

Technical Product Handbook



The shower drainage option designed to impress

QuARTz by ACO bathroom drainage solutions inspire creative bathroom planning. Shower channels and new ShowerPoint area drains are suitable for traditional curb shower design or allow the elimination of physical barriers within the bathroom floor for a more contemporary look or to comply with universal design concepts.

Gratings are available in a choice of slot patterns and can be easily replaced at a later date to generate a totally new look.

Water activated LED lights are also available, and can be added at any stage, to create a totally different shower experience and feel.

Quality and functionality

The high quality of the components is not limited to the design, materials and finish; ease of handling and installation are also given the same attention to detail.

The difference is in the details

Products are designed to provide a long, reliable service life. The smooth surfaces guarantee safe drainage and hygiene in bathrooms. The seals, joints and materials guarantee low noise emissions.

Award-winning design

The stainless steel gratings visibly demonstrate the quality of the shower channels and drains. QuARTz by ACO shower channel gives any number of opportunities to impress through quality and looks!



■ Linear ShowerChannel solutions

A choice of eight grating designs, two material finishes in six standard lengths and two edge details provide the solution to most bathrooms. Custom solutions are also available.

Page 3



■ ShowerPoint solutions

A high quality traditional area drain with five grating designs offers all the additional design features of the QuARTz shower channels.

Page 17

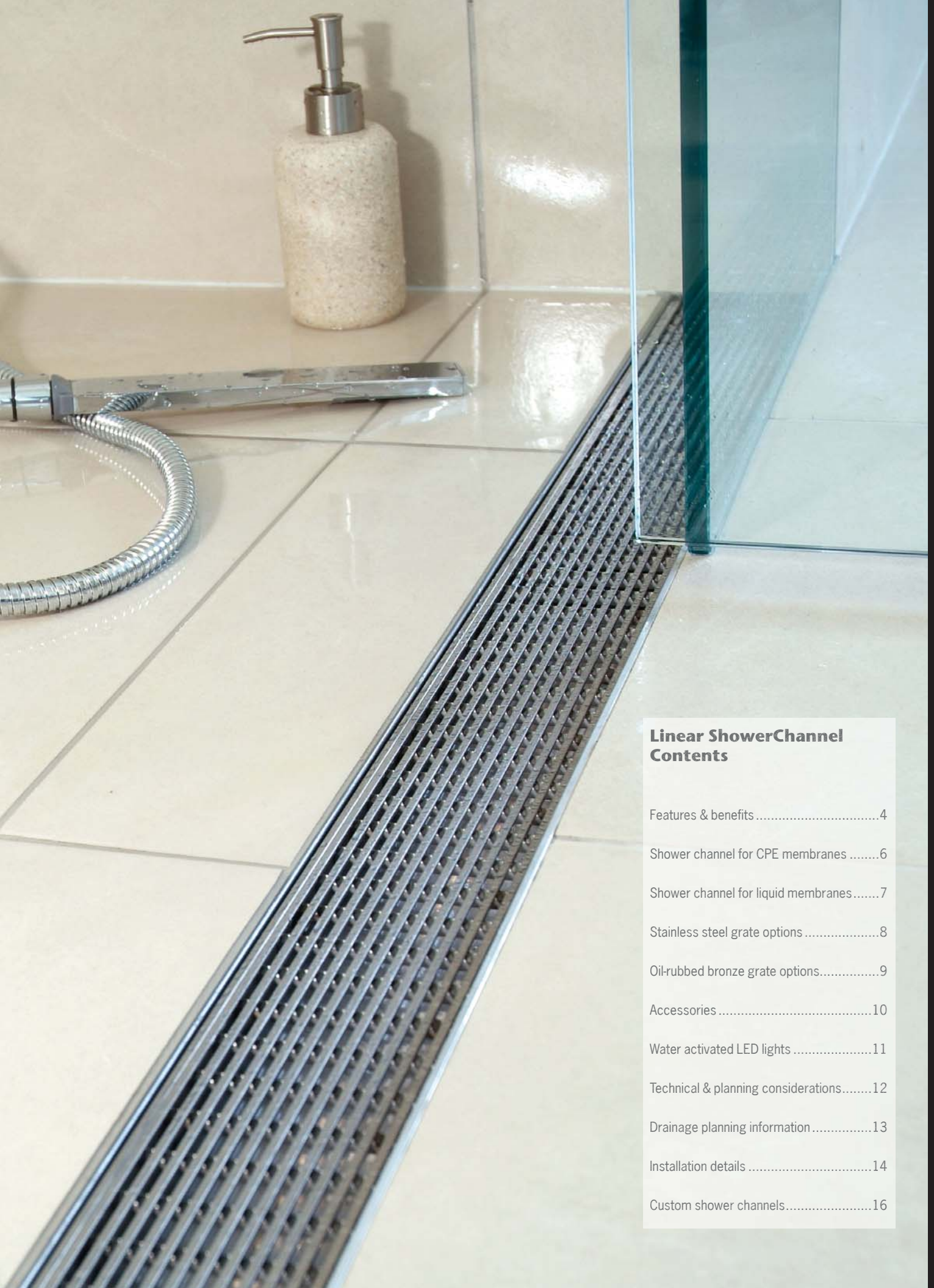

**Linear ShowerChannel
Contents**

Features & benefits4

Shower channel for CPE membranes6

Shower channel for liquid membranes7

Stainless steel grate options8

Oil-rubbed bronze grate options9

Accessories10

Water activated LED lights11

Technical & planning considerations12

Drainage planning information13

Installation details14

Custom shower channels16

Features & Benefits:

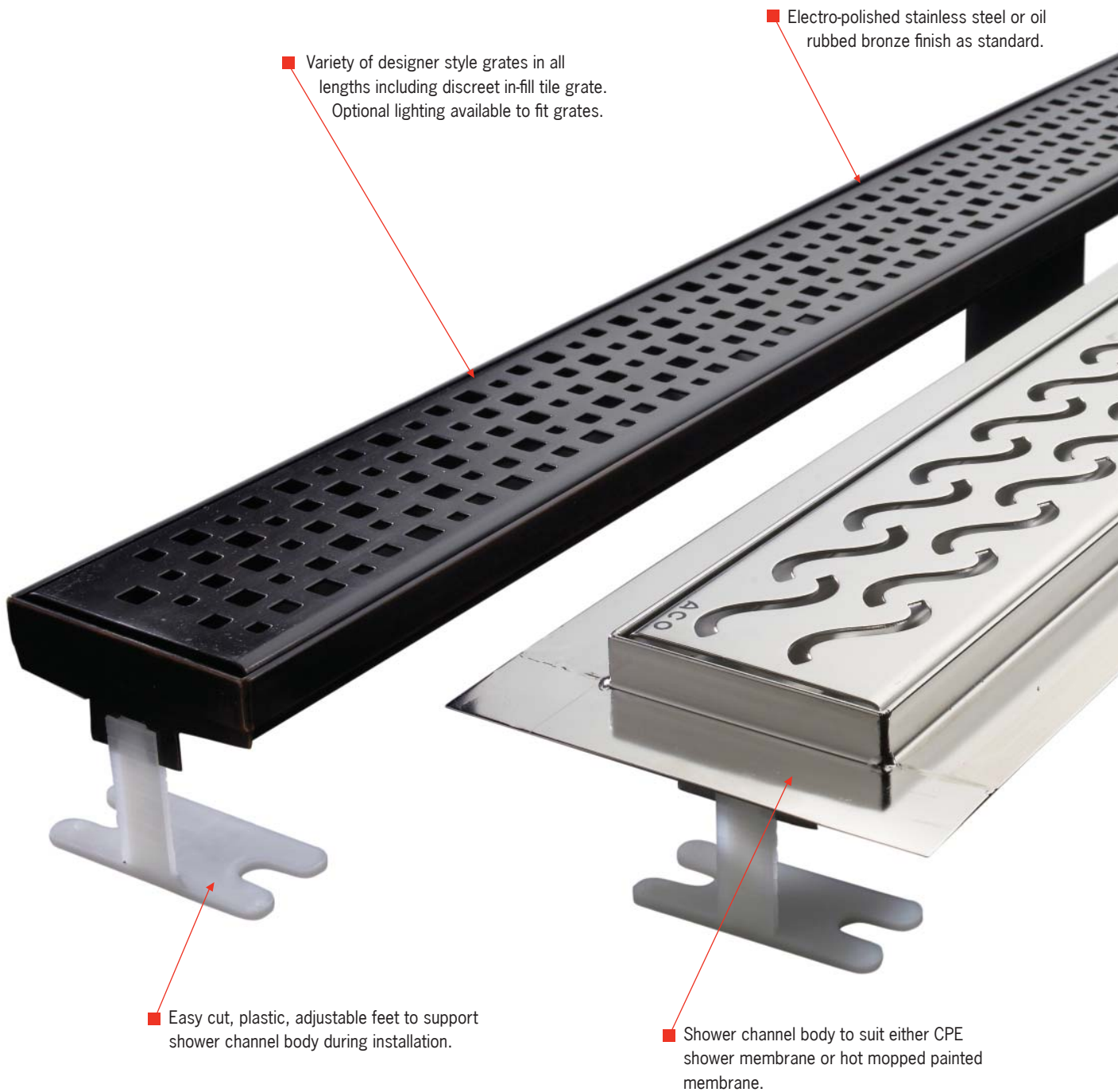



■ Variety of lengths from 700 mm (27.55") to 1400 mm (55.12") as standard.

■ Shallow 'V' channel profile to aid flow of water to outlet.

■ Centrally located 2" stainless steel spigot outlet with optional debris strainer.

■ Pipe connectors available for either CPE membranes or straight outlet to plumbing pipe.

■ All bodies and grates are 304 stainless steel.

Shower channel solution for plastic liner membranes - plain edge



Features

- 2" diameter central vertical outlet
- Flow rate: at entrance of shower - 6.65 GPM (0.4 l/s); against the wall - 9.51 GPM (0.6 l/s). See page 12.
- Channel width: 3.3" (84 mm)
- Electro-polished and oil-rubbed bronze finishes
- Designed for use with CPE membrane fitting
- Plastic support feet aid installation
- Optional accessories include plumbing connectors, water activated LED lights and debris strainer (see page 10-11).

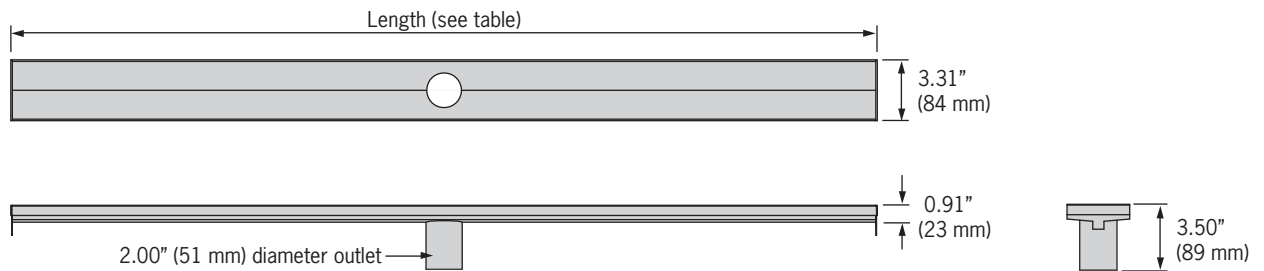

Product Table - channel only (select grate from page 8-9)

Length (mm) inches	700 27.55	800 31.50	900 35.43	1000 39.37	1200 47.25	1400 55.12
Part No. Electro-polished	93861	93864	93865	93869	93872	93816
Part No. Oil-rubbed bronze	93180	93187	93184	93189	93182	93177
Weight lbs	2.5	2.6	3.0	3.2	3.7	4.2

Shower channel solution for liquid or bonded membranes - flange edge



Features

- 2" diameter central vertical outlet
- Flow rate: at entrance of shower - 6.65 GPM (0.4 l/s); against the wall - 9.51 GPM (0.6 l/s). See page 12.
- Channel width: 3.3" (84 mm)
- Electro-polished and oil-rubbed bronze finishes
- Designed for use with 'hot-mop', painted or liquid membranes
- Compatible with tiles up to 10 mm thick (14 mm lip)
- Stainless steel clad flexible coupling connects outlet to pipe system
- Plastic support feet aid installation
- Optional accessories include plumbing connectors, water activated LED lights and debris strainer (see page 10-11).

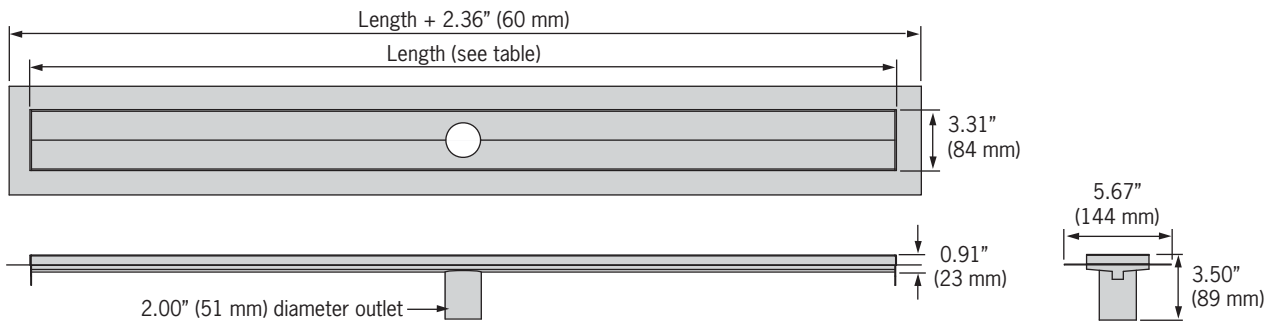









Product Table - channel only (select grate from page 8-9)

Length (mm) inches	700 27.55	800 31.50	900 35.43	1000 39.37	1200 47.25	1400 55.12
Part No. Electro-polished	93866	93873	93862	93870	93875	93817
Part No. Oil-rubbed bronze	93188	93181	93183	93186	93185	93178
Weight lbs	3.4	3.6	4.1	4.5	5.2	5.9

Stainless steel grating designs

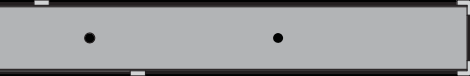





Product Table

Design	Length in. (mm)	Part no.	Intake sq. in.
 Wave™	27.55 (700)	37342	13.66
	31.50 (800)	37343	15.57
	35.43 (900)	37344	17.48
	39.37 (1000)	37345	19.39
	47.25 (1200)	37346	23.20
	55.12 (1400)	37413	27.01
 Quadrato™	27.55 (700)	37359	15.39
	31.50 (800)	37360	17.71
	35.43 (900)	37361	20.03
	39.37 (1000)	37362	22.35
	47.25 (1200)	37363	26.68
	55.12 (1400)	37418	31.01
 Flag™	27.55 (700)	37369	21.33
	31.50 (800)	37370	25.10
	35.43 (900)	37371	28.85
	39.37 (1000)	37372	31.36
	47.25 (1200)	37373	36.37
	55.12 (1400)	37417	41.38
 Hawaii™	27.55 (700)	37398	15.73
	31.50 (800)	37399	17.48
	35.43 (900)	37400	19.22
	39.37 (1000)	37401	22.72
	47.25 (1200)	37402	26.22
	55.12 (1400)	37414	29.72
 Mix™	27.55 (700)	37403	18.54
	31.50 (800)	37404	20.88
	35.43 (900)	37405	23.56
	39.37 (1000)	37406	26.47
	47.25 (1200)	37407	27.71
	55.12 (1400)	37415	28.95
 Pixel™	27.55 (700)	37408	17.13
	31.50 (800)	37409	19.00
	35.43 (900)	37410	21.48
	39.37 (1000)	37411	24.20
	47.25 (1200)	37412	29.00
	55.12 (1400)	37416	33.80
 Tile™	27.55 (700)	37335	13.00
	31.50 (800)	37338	14.69
	35.43 (900)	37336	16.42
	39.37 (1000)	37334	18.10
	47.25 (1200)	37332	21.50
	55.12 (1400)	37419	24.90
 Linear™	27.55 (700)	37420	38.60
	31.50 (800)	37421	44.22
	35.43 (900)	37422	49.80
	39.37 (1000)	37423	55.38
	47.25 (1200)	37424	66.53
	55.12 (1400)	37425	77.68



Oil-rubbed bronze grating designs

Product Table

Design	Length in. (mm)	Part no.	Intake sq. in.
 Wave™	27.55 (700)	37312	13.66
	31.50 (800)	37321	15.57
	35.43 (900)	37308	17.48
	39.37 (1000)	37313	19.39
	47.25 (1200)	37302	23.20
	55.12 (1400)	37292	27.01
 Quadrato™	27.55 (700)	37317	15.39
	31.50 (800)	37309	17.71
	35.43 (900)	37303	20.03
	39.37 (1000)	37320	22.35
	47.25 (1200)	37307	26.68
	55.12 (1400)	37297	31.01
 Flag™	27.55 (700)	37324	21.33
	31.50 (800)	37306	25.10
	35.43 (900)	37315	28.85
	39.37 (1000)	37322	31.36
	47.25 (1200)	37311	36.37
	55.12 (1400)	37296	41.38
 Hawaii™	27.55 (700)	37330	15.73
	31.50 (800)	37314	17.48
	35.43 (900)	37305	19.22
	39.37 (1000)	37325	22.72
	47.25 (1200)	37318	26.22
	55.12 (1400)	37293	29.72
 Mix™	27.55 (700)	37301	18.54
	31.50 (800)	37326	20.88
	35.43 (900)	37340	23.56
	39.37 (1000)	37319	26.47
	47.25 (1200)	37329	27.71
	55.12 (1400)	37294	28.95
 Pixel™	27.55 (700)	37304	17.13
	31.50 (800)	37333	19.00
	35.43 (900)	37328	21.48
	39.37 (1000)	37337	24.20
	47.25 (1200)	37316	29.00
	55.12 (1400)	37295	33.80
 Tile™	27.55 (700)	37327	13.00
	31.50 (800)	37300	14.69
	35.43 (900)	37331	16.42
	39.37 (1000)	37323	18.10
	47.25 (1200)	37310	21.50
	55.12 (1400)	37298	24.90



Accessories

A number of accessories are available to ensure an aesthetic and trouble-free installation.

Plumbing fittings

In order to connect the 2" plain end spigot to the plumbing system a connection fitting will be required. QuARTz by ACO offer a choice of three:

- PVC membrane fitting - typically used with the plain body channel. Allows connection and clamping of a CPE flexible membrane.
- Cast Iron membrane fitting – typically used with the plain body channel. Allows connection and clamping of either fabric or 'hot-mop' membrane. Also suitable when plastic fittings are considered a fire hazard.
- Stainless steel clad flexible coupling - typically used with the flanged body channel. Used where a 'hot-mop' painted membrane is applied. Stainless steel cladding ensures connector is suitable where plastic fittings are considered a fire hazard.



PVC membrane connector



Stainless steel coupling connector



Cast iron membrane connector



Debris strainer

Debris strainer

A stainless steel sieve/strainer that sits inside the 2" diameter outlet to collect hair and debris. Note that use of strainer will reduce the flow performance of the shower channel.

Product Table

Description	Part No.	Weight
PVC CPE membrane coupling	93871	1.1
Iron CPE membrane coupling	93822	4.7
Stainless steel clad coupling	93874	0.4
Debris strainer - electro polished	37381	0.1
Debris strainer - oil-rubbed bronze	37382	0.1

Water activated LED lights

Illumination is possible for both standard and custom shower channels. The illumination is based on simple circuit completion: as sufficient water runs over the LED light packs the circuit connects the contacts of the LED light modules and the lights turn on. When the water stops running the illumination switches off.

Allowing a daily showering duration of 15 minutes, batteries would need to be recharged after approx. three months.

- Suitable for all grate designs except Tile and Linear
- Automatically illuminate when in contact with water
- Light kit consisting of:
 - 2 x rechargeable LED packs
 - 1 x 110V UL rated low voltage charger
- Choice of colors; red, green, blue, rainbow (alternating colors)

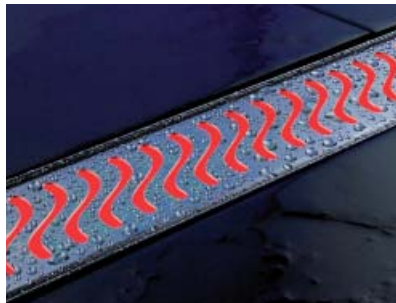

Red

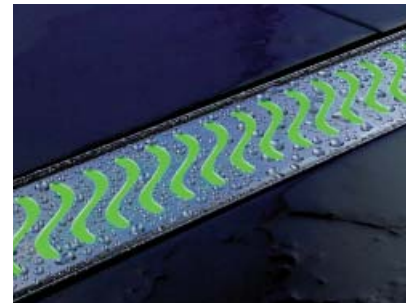

Green



LED light packs, charging unit and power cord

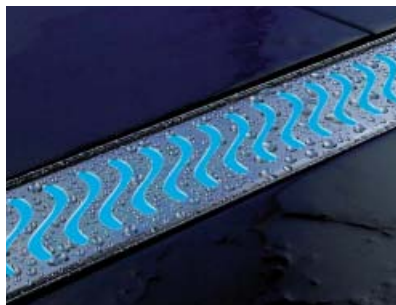

Blue

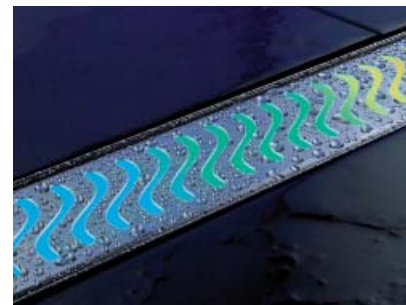

Rainbow (alternating colors)

Product Table

Description	Part No.	Weight
Red LED light kit	37377	1.5
Green LED light kit	37375	1.5
Blue LED light kit	37379	1.5
Rainbow LED light kit	37374	1.5

Note: Weight includes 2 lights, charger and adapter

Technical & planning considerations

Accumulation and slopes

ASME A112.6.3-2001 requires a 2" outlet for shower applications. QuARTz by ACO channels have this as standard. The flow value for a 2" outlet varies depending upon the head of water above the grating.

In the case of shower channels, a head of water is not typical in practice, due to shallower floor grades. Area drains can have a head of water due to 'basin' profile of floor grades.

Flow values without any accumulation (head of water) should be used when shower channels are placed around the perimeter of the shower and no shower threshold step is used.

If the shower channel is installed against a wall, there may be a small amount of accumulation (head of water) depending on the layout of the shower area. Grade of shower floor will determine depth of build-up.



Installation against the wall.

Outlet flow rate up to 9.51 GPM based on floor grades such that 0.2" (5 mm) head of water possible.



Installation at the entrance

Outlet flow rate up to 6.65 GPM based on no water accumulation (head of water).

Outlet flow rates (GPM)

Grate	Accumulation (head of water above grate)		
	0" (0mm)	0.2" (5mm)	0.6" (15mm)
Channel body only	6.65	9.51	11.60

The addition of a grate can throttle the intake of water into the channel body and slow the flow of water to the outlet.

Effect of grate on outlet flow rates (GPM)

Grate	Accumulation (head of water above grate)		
	0" (0mm)	0.2" (5mm)	0.6" (15mm)
Wave	6.00	8.58	10.47
Quadrato	6.34	9.07	11.06
Flag	6.34	9.07	11.06
Hawaii	6.36	9.09	11.08
Mix	6.40	9.15	11.16
Pixel	6.58	9.12	11.12
Tile	6.49	9.28	11.32
Linear*	6.65	9.51	11.60

Note: Based on 900mm shower drain with standard 2" outlet.

* Linear grate flow rate exceeds capacity of the channel and is therefore rated at the channel flow rates.

Outflow performance

The choice of shower channel generally depends on the flow values of the shower fitting. 70 % of shower heads have a maximum capacity of less than 3 GPM.

The QuARTz by ACO shower drain standard channel has an outflow of 6.65 GPM. This value assumes no head of water above drain.

Based upon these flow rates the QuARTz by ACO shower drain standard channel can be used in conjunction with the majority of shower head fittings.

A number of custom solutions are available to cope with shower heads with higher flow rates (see page 16).

Drainage planning information

Linear drainage options		
Installation against the wall	Walk-through: Installation against the wall	Walk-in: Installation against the wall
<p>Simplest slope solution in one direction – slope away from the bathroom – no risk of bypass – use of CPE flexible membrane is recommended.</p>	<p>Slope in one direction – just shower area or whole bathroom floor can be sloped towards channel – use of CPE flexible membrane is recommended.</p>	<p>Simplest slope solution in one direction – slope away from the bathroom – no risk of overshooting water – use of CPE flexible membrane is recommended.</p>
Installation at shower entrance	Walk-through: Installation with two channels	Walk-in: Installation at the entrance
<p>Slope in one direction, towards the bathroom – possible risk of bypass – slope of bathroom floor towards shower area is recommended to prevent bypass. Channel length should exactly fit the shower opening.</p>	<p>Two directional slope towards the bathroom. Channel length should exactly fit the shower opening.</p>	<p>Two directional slope towards the channel. Channel length should exactly fit the shower opening.</p>

Installation overview

Tiled showers rely on waterproofing membrane beneath the tiles and grout. QuARTz by ACO offers a number of options to ensure compatibility with different floor structures.

The installation details shown set out to provide the designer with integrated solutions to wet room floor drainage identifying preparation, installation and construction processes required to install waterproof channels and floor drains in level threshold wet room environments.

Although these details do not cover every possible situation, they do provide a practical reference to most design applications.

Plain body - plastic liner membranes

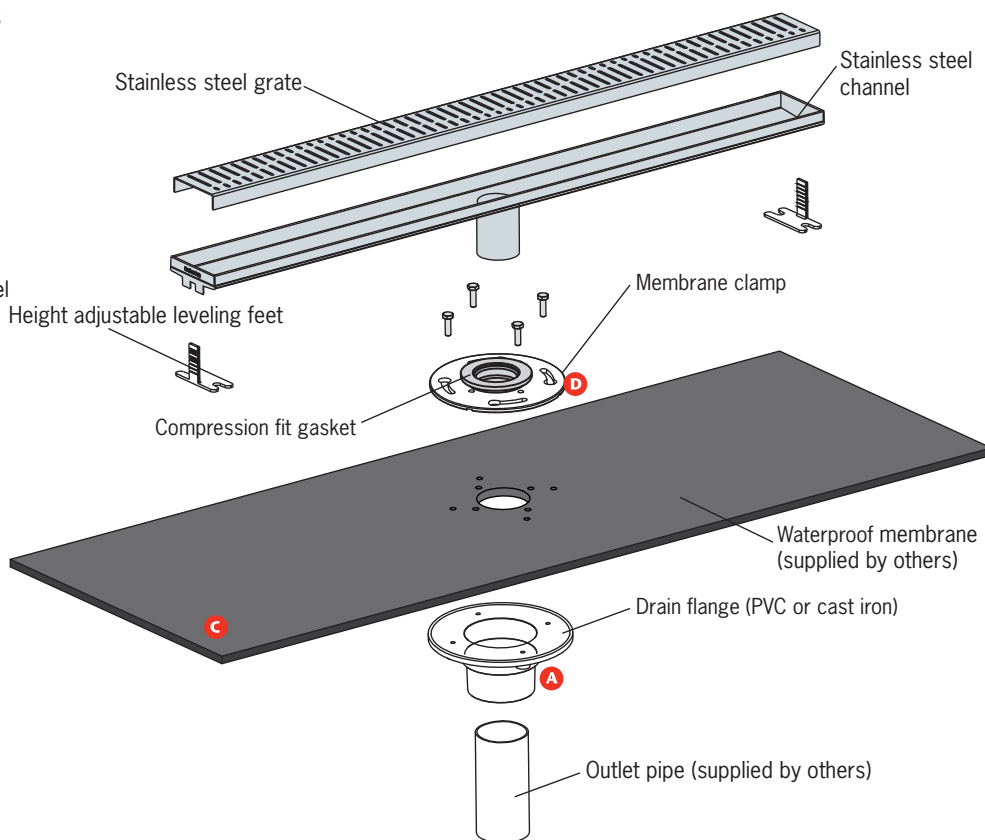

1. Where alterations to floor joists are necessary, consult Structural Engineer for advice and reinforce floor joists as advised.
2. Frame out shower surround as required.
3. Connect base of flange outlet adaptor **A** to pipe work, leaving drain bolts in place. Block drain opening with rag to prevent floor mortar blocking pipe work.
4. Trowel mortar onto sub-floor **B**.
5. Install CPE membrane **C**, reinforce around outlet and cut carefully to reveal heads of drain bolts and outlet.
6. Install top section of flange outlet adaptor **D**.
7. Test membrane for leaks.
8. Lubricate outlet spigot on shower channel (liquid soap) and push fit shower channel into outlet at correct position and height.
9. Cut plastic installation feet to height to rest on the membrane and keep shower channel at required height and level.
10. Trowel mortar to required height **E**, allowing for thickness of tile and thin set mortar and grade to create 1% slope towards the drain.
11. After floor mortar has cured, apply thin set **F** and install tile and grout **G**.
12. Install grate into shower channel.

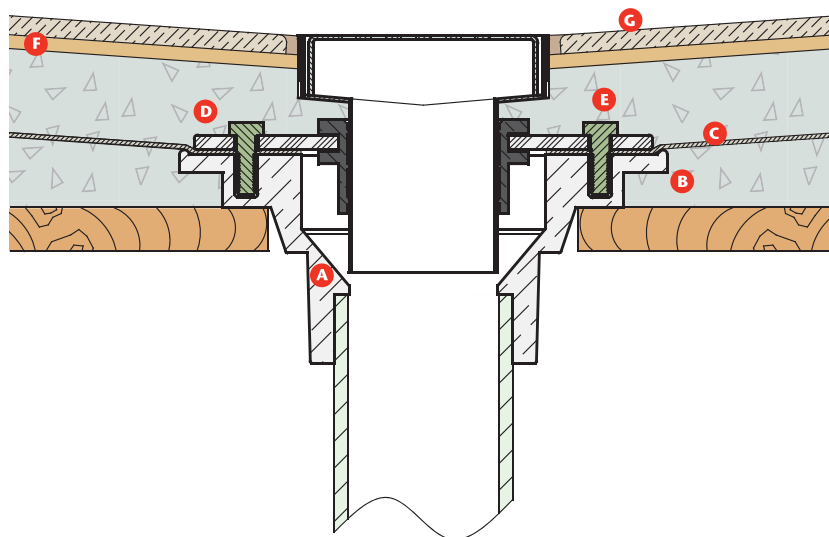

Flange body - liquid or bonded membranes

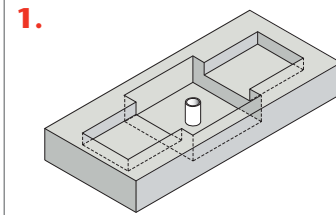
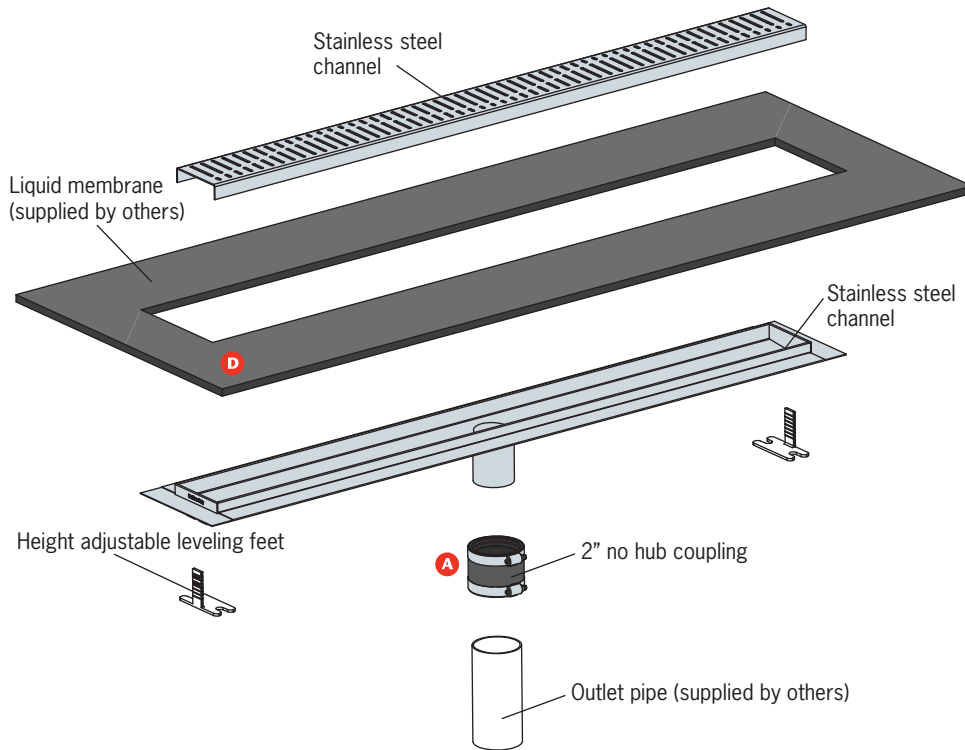

Box out detail showing suggested dimensions

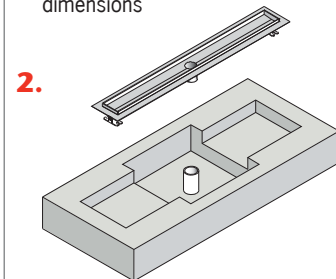

After removing box form work connect shower channel to plumbing pipe work using stainless steel connector part number 93874.

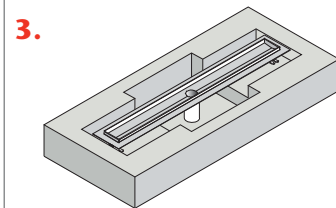

Shower channel fitted in place prior to final concrete slurry pour. Shower channel flange should be at same level as original concrete slab.

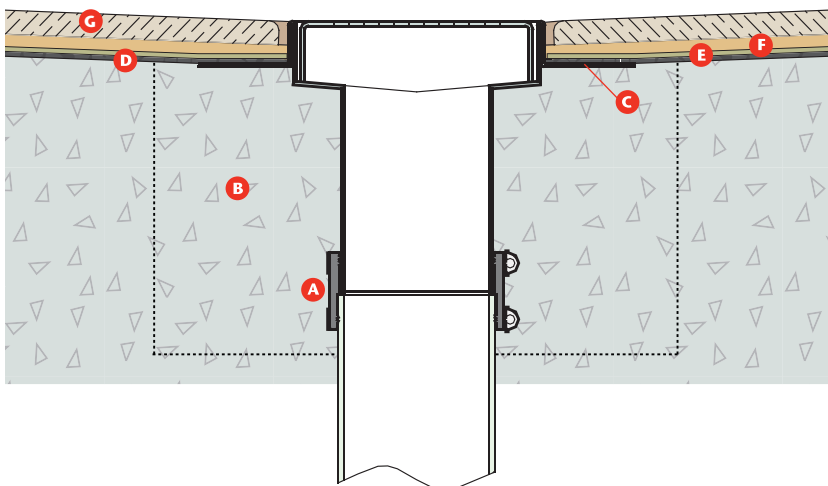

- 1.** Frame out shower surround in concrete slab as required, see diagram top right.
- 2.** Set top edge of shower channel slightly below finished tile level, cut plastic installation feet to height to hold shower channel at required height and level.
- 3.** Connect outlet to pipe work using 2" stainless coupler **A**.
- 4.** Pour concrete slurry **B** into framed out void in concrete slab to height of flange on channel body **C**.
- 5.** Install 'hot-mop'/liquid membrane **D**, fully covering concrete and flange of shower channel in accordance with manufacturer's instructions.
- 6.** Trowel mortar to required height and grade, approx. 1% **E**.
- 7.** Apply thin set **F**.
- 8.** Lay tile and grout **C**.
- 9.** Install grate into shower channel.

Custom Shower Channels

For projects requiring a number of units and where standard channels are not appropriate, a number of features can be customized to ensure the unit meets required performance criteria.

Note: All diagrams show flanged shower channel body. Custom features are also available on plain shower channel bodies. Custom channels are only available in electro-polished finish.

1. Length of shower channel

To meet specific room requirements the channel can be manufactured to specific length requirements - minimum 12" and maximum 192". Standard length grates are used, this may result in multiple grates per channel.

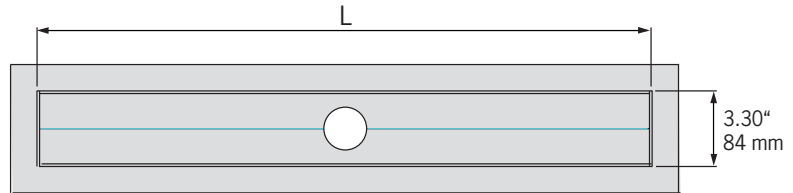

Length L = inches Width is fixed at 3.30" (84 mm)

Note: For flange body overall width is 5.67" (144 mm); Overall length is L + 2.36" (60 mm)

2. Position of 2" outlet

Plumbing layout restrictions may require a non-central outlet - the position of the outlet can be manufactured to suit site requirements.

Center position	<p>A side-view diagram of a shower channel with a central outlet. Two horizontal dimension lines above the channel, each labeled 'L/2', indicate the distance from the center of the outlet to the left and right ends of the channel.</p>	Standard version
End position	<p>A side-view diagram of a shower channel with an outlet at the left end. A horizontal dimension line labeled 'L1' shows the distance from the left end to the center of the outlet. Another horizontal dimension line labeled 'L2' shows the distance from the center of the outlet to the right end.</p>	L1 = inches L2 = inches
Custom position	<p>A side-view diagram of a shower channel with an outlet at a custom position. A horizontal dimension line labeled 'L1' shows the distance from the left end to the center of the outlet. Another horizontal dimension line labeled 'L2' shows the distance from the center of the outlet to the right end.</p>	L1 = inches L2 = inches

3. Number of 2" outlets

To meet hydraulic requirements of multiple shower heads the number of outlets can be increased. Outlet size is fixed at 2" diameter due to the width of the unit and availability of compatible plumbing connections.

Two outlets	<p>A side-view diagram of a shower channel with two outlets. Horizontal dimension lines above the channel are labeled 'L1' (from left end to first outlet), 'L2' (between outlets), and 'L3' (from second outlet to right end).</p>	L1 = inches L2 = inches L3 = inches
Three outlets	<p>A side-view diagram of a shower channel with three outlets. Horizontal dimension lines above the channel are labeled 'L1' (from left end to first outlet), 'L2' (between first and second outlets), 'L3' (between second and third outlets), and 'L4' (from third outlet to right end).</p>	L1 = inches L2 = inches L3 = inches L4 = inches

ShowerPoint Contents

Features & benefits	18
ShowerPoint grate options.....	19
Technical & planning considerations.....	20
Drainage planning information	21
Water activated LED lights	21
Accessories	22
Installation details	23









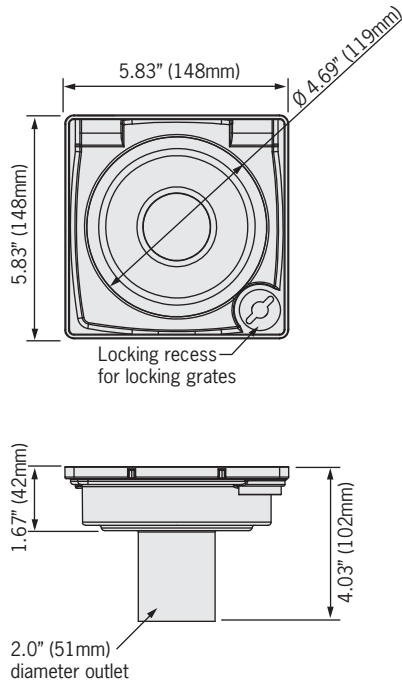



Features & Benefits:



ShowerPoint grating designs



Product Table

Design		Weight lbs	Part no. Locking/Non	Intake sq. in.
		1.6	37234	8.7
Locking	Non-locking		37221	
Wave				
		1.6	37233	4.9
Locking	Non-locking		37225	
Quadrato				
		1.6	37230	6.5
Locking	Non-locking		37223	
Hawaii				
		1.6	37231	6.2
Locking	Non-locking		37222	
Mix				
		1.6	37232	5.8
Locking	Non-locking		37224	
Pixel				

Grate unlocking/locking



Place coin into slot and rotate clockwise



Once released spring will eject grate



Lift grate with the key.

To lock: reverse process.

Technical & planning considerations

Accumulation and slopes

ASME A112.6.3-2001 requires a 2" outlet for shower applications. QuARTz by ACO ShowerPoint drains have this as standard. The flow value for a 2" outlet varies depending upon the head of water above the grating.

Flow values with no or minimal accumulation (head of water) should be used when shower drain is placed within the general bathroom floor area.

If the shower drain is installed within the shower stall, there will be a head of water due to 'basin' profile of floor grades; amount of accumulation (head of water) will vary depending on the layout of the shower area. The floor within the shower can be created with a higher gradient and/or the shower may have a lip which will increase accumulation (head of water).



Installation within the bathroom

Outlet flow rate up to 17.4 GPM based on minimal water accumulation (head of water).



Installation within the shower

Outlet flow rate up to 31.7 GPM based on floor grades such that 0.6" (15 mm) head of water possible.

ShowerPoint outlet flow rates (GPM)

Grate	Accumulation (head of water above grate)	
	0.2" (5mm)	0.6" (15mm)
Wave	17.4	31.7
Quadrato	9.5	17.4
Hawaii	14.3	23.8
Mix	12.7	22.2
Pixel	12.7	22.2

Outflow performance

The choice of shower drain generally depends on the flow values of the shower fitting. 70% of shower heads have a maximum capacity of less than 3 GPM.

The QuARTz by ACO ShowerPoint drains have an outflow of up to 31.7 GPM. This value assumes a 0.6" (15mm) head of water above drain.

Based upon these flow rates the QuARTz by ACO ShowerPoint drains can be used in conjunction with the majority of shower head fittings.

Drainage planning information

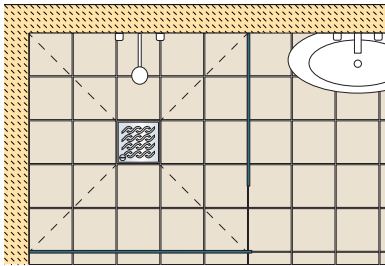
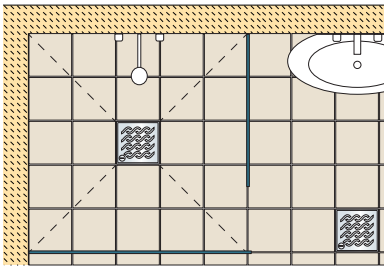
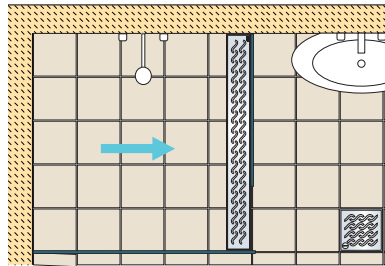
Point drainage options		
Use ShowerPoint within shower area	Use ShowerPoint within shower and bathroom areas	Use ShowerPoint within bathroom area and linear shower drain within shower area
		
Using a single ShowerPoint drain positioned within the shower area. Floors must be graded appropriately or other barriers must be used to prevent flow of water into bathroom area.	Using multiple ShowerPoint drains positioned within both the shower and bathroom areas. Level threshold floors can be utilized as bathroom ShowerPoint will drain any overflow from the shower. Bathroom area ShowerPoint will also drain any spills or leaks from cleaning or other bathroom fixtures.	Using a ShowerPoint drain positioned within bathroom area and linear shower drain within shower area. Level threshold floors can be utilized as bathroom ShowerPoint will drain any overflow from the shower. Bathroom area ShowerPoint will also drain any spills or leaks from cleaning or other bathroom fixtures.

Accessories

Water activated LED lights



Water activated LED light unit; sits below the grate and illuminates whenever the water is running. Available in red, green, blue or white.

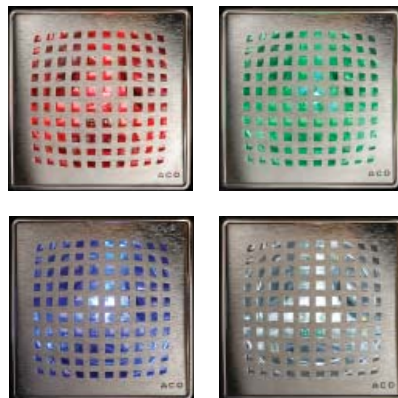

Product Table

Description	Part No.	Weight
ShowerPoint LED light - red	37254	0.5
ShowerPoint LED light - green	37252	0.5
ShowerPoint LED light - blue	37253	0.5
ShowerPoint LED light - white	37251	0.5

Accessories

Plumbing fittings

In order to connect the 2" plain end spigot to the plumbing system a connection fitting will be required.

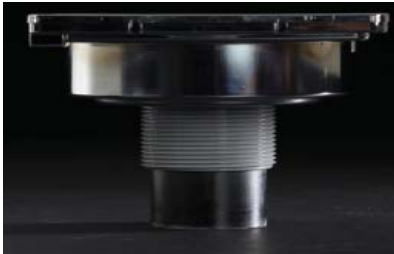

Threaded coupling that can be solvent welded to the outlet pipe and is compatible with any standard 2" threaded drain flange. Once coupling is in place remove remaining outlet tail to prevent damage to membrane.

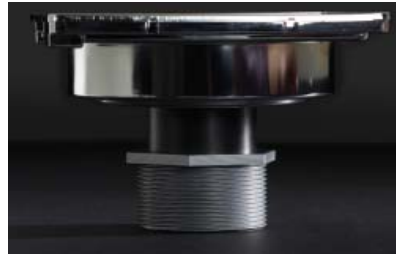

Threaded coupling with hub that can be compatible with any standard 2" threaded drain flange - position at required height, apply solvent weld, drop shower drain in at desired orientation to fit tiling pattern. 2" NSP thread.



2" Stainless steel clad flexible coupling - typically used where plastic fittings are considered a fire hazard.

Debris strainer



A stainless steel sieve/debris strainer that sits inside the 2" diameter outlet to collect hair and debris. Note that use of strainer will reduce the flow performance of the shower drain.

Product Table

Description	Part No.	Weight
Stainless steel clad coupling	93874	0.4
Debris strainer	37381	0.1

Installation overview

Tiled showers rely on a waterproofing membrane beneath the tiles and grout. QuARTz by ACO offers a number of options to ensure compatibility with different floor structures.

The installation details shown set out to provide the designer with integrated solutions to wet room floor drainage identifying preparation, installation and construction processes required to install waterproof channels and floor drains in level threshold wet room environments.

Although these details do not cover every possible situation, they do provide a practical reference to most design applications.

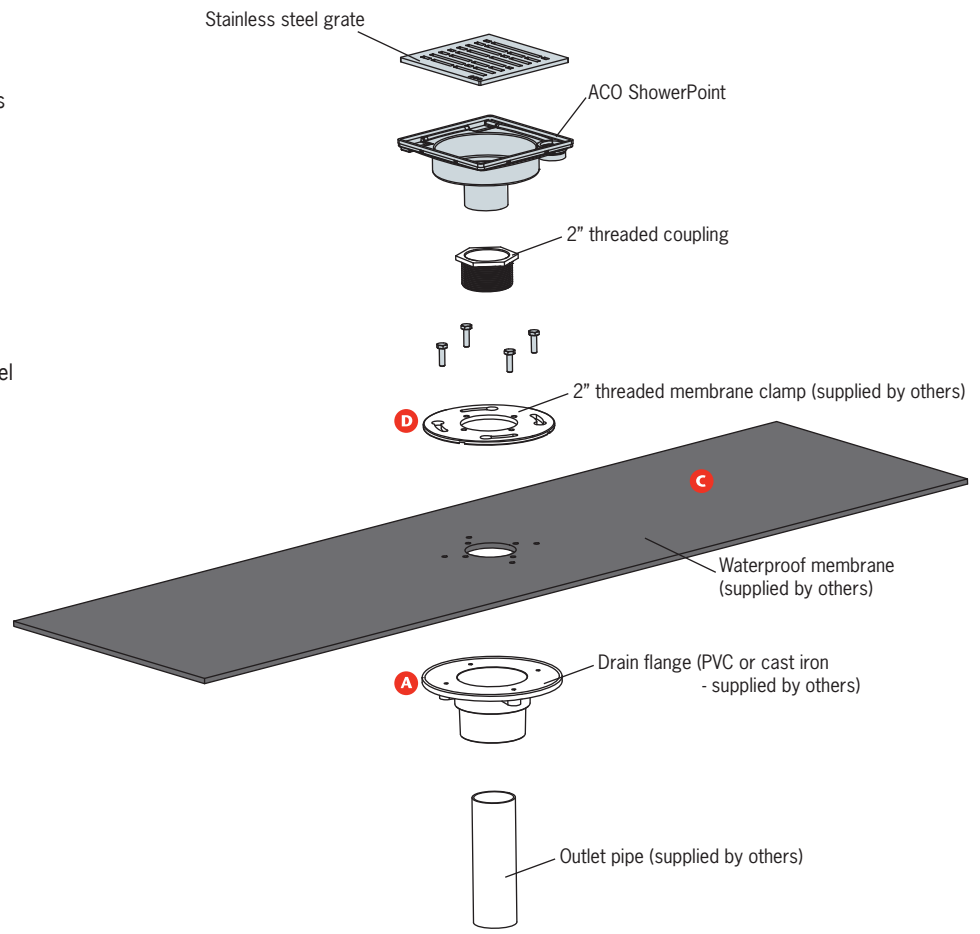

1. Where alterations to floor joists are necessary consult Structural Engineer for advice and reinforce floor joists as advised.
2. Frame out shower surround as required.
3. Connect base of drain flange **A** to pipe work, leaving drain bolts in place. Block drain opening with rag to prevent floor mortar blocking pipe work.
4. Trowel mortar onto sub-floor **B**.
5. Install CPE membrane **C**, reinforce around outlet and cut carefully to reveal heads of drain bolts and outlet.
6. Install top section of drain flange **D**.
7. Test membrane for leaks.
8. Screw fit ShowerPoint drain to correct position and height.
9. Trowel mortar to required height **E**, allowing for thickness of tile and thin set mortar and grade to create 1% slope towards the drain.
10. After floor mortar has cured, apply thin set **F** and install tile and grout **G**.
11. Install grate into ShowerPoint drain.

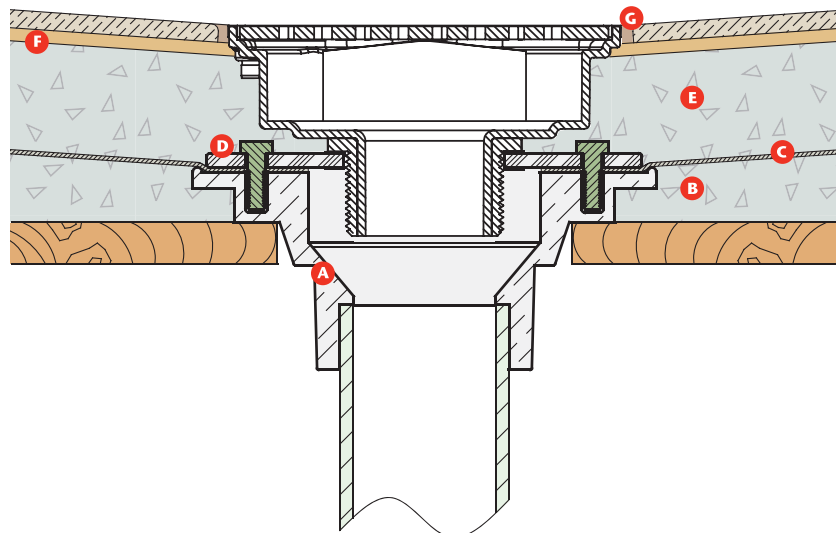



Other ACO product lines

- **ACO SPORT**
Surface drainage and building accessories for track & field, used at Olympic sites since 1972.
- **AQUADUCT**
Custom designs and manufactures fiberglass trench drain systems to meet individual project requirements.
- **ACO INFRASTRUCTURE**
Surface drainage products engineered for the unique design and performance demands of highways, urban roads and bridges.
- **ACO SIDEWALK**
ADA compliant, detectable warning devices, in a choice of sizes and colors.
- **ACO ENVIRONMENT**
Separator and spill containment systems.
- **ACO WILDLIFE**
Tunnel and fence system designed to guide amphibians and other small creatures safely across roads.
- **MARKANT BY ACO**
Simple plastic and polymer concrete trench units for use around the home, garden and office.
- **QUARTZ BY ACO**
Stainless steel shower drains and accessories for tiled showers.

QuARTz by ACO is a division of ACO Polymer Products, Inc.

ACO Polymer Products, Inc.

West Sales Office

P.O. Box 12067
Casa Grande, AZ 85130
Tel: (520) 421-9988
Toll Free: (888) 490-9552
Fax: (520) 421-9899

North East Sales Office

P.O. Box 245
Chardon, OH 44024
Tel: (440) 285-7000
Toll free: (800) 543-4764
Fax: (440) 285-7005

South East Sales Office

4211 Pleasant Road
Fort Mill, SC 29708
Toll free: (800) 543-4764
Fax: (704) 568-4387

Electronic Contact:

info@QuARTzbyACO.com
www.QuARTzbyACO.com



Follow us on



© August 2012 ACO Polymer Products, Inc.

All reasonable care has been taken in compiling the information in this document. All recommendations and suggestions on the use of ACO products are made without guarantee since the conditions of use are beyond the control of the Company. It is the customer's responsibility to ensure that each product is fit for its intended purpose and that the actual conditions of use are suitable. ACO Polymer Products, Inc. reserves the right to change products and specifications without notice.

Re-order Part # QL003